

# REVOLT

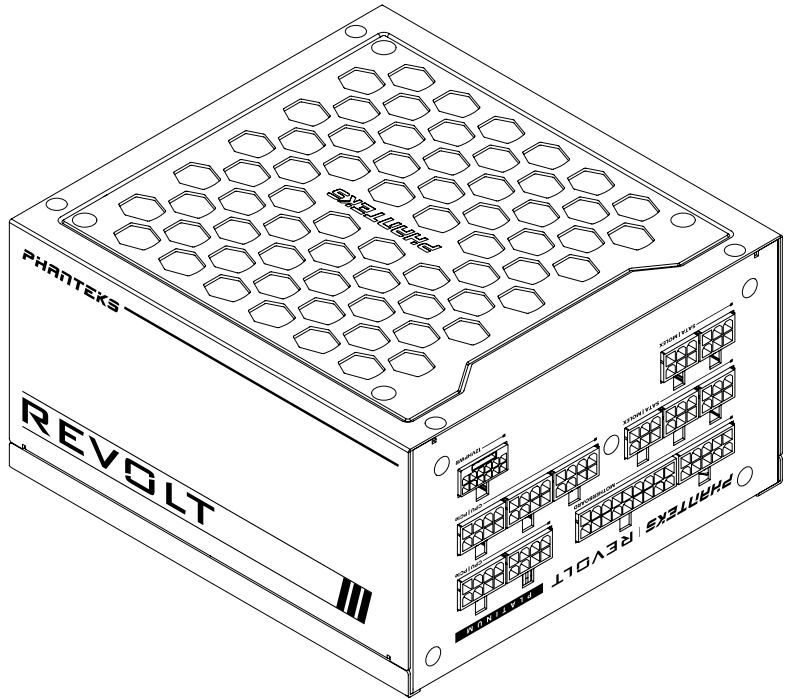

## INSTALLATION GUIDE SUPPORTS

- PH-P1000PR\_BK01C
- PH-P1000PR\_WT01C
- PH-P1200PR\_BK01C
- PH-P1200PR\_WT01C
- PH-P1600PR\_BK01C
- PH-P1600PR\_WT01C
- PH-P1300TR\_BK01C
- PH-P1300TR\_WT01C
- PH-P1600TR\_BK01C
- PH-P1600TR\_WT01C

## ACCESSORIES INCLUDED

INCLUDED ACCESSORIES	POWER SUPPLY REVOLT	MANUAL WARRANTY	POWER CABLE 1500MM
User Manual			
Installation Guide			
PSU Bag			
Zip Tie Bag	ZIP TIE BAG	VELCRO BAG	SCREW PACK
Velcro Bag			
Screw Pack			
Power Cable			

## AVAILABLE OUTPUT CONNECTORS

MOTHERBOARD 10+18-PIN	CPU   PCIe 8-PIN	PCIe GEN5.1 12V-2X6	SATA   MOLEX 6-PIN

CONNECTOR QUANTITY	1000/1200 watt models	1300 watt models	1600 watt models
Motherboard 10+18-PIN	1	1	1
CPU   PCIe 8-PIN	5	9	9
PCIe GEN5.1 12V-2x6	1	1	2
SATA   MOLEX	5	6	6

## FOLLOW US ON SOCIAL MEDIA

**Instagram**  
Phanteks

**Facebook**  
Phanteks

**YouTube**  
Phanteks

**Twitter**  
@phanteks

## SUPPORT

**US & Canada**  
support@phanteksusa.com

**International**  
support@phanteks.com

**01 CHOOSE YOUR CABLES**

The Revolt power supply comes as a cable free model, cables are purchased separately. Make sure the cables are compatible with the Phanteks Revolt power supply before proceeding.

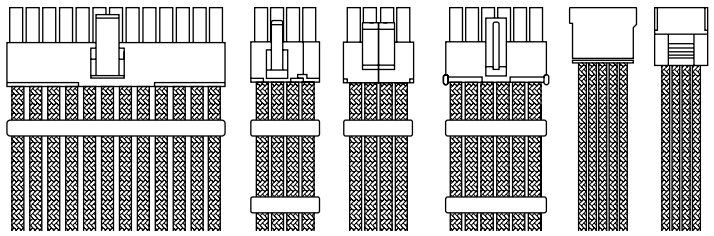

Cables sold separately

**02 INSTALL POWER SUPPLY INTO CHASSIS**

Install the Revolt PSU in the computer chassis using the 4x PSU screws. Follow the chassis instruction manual.

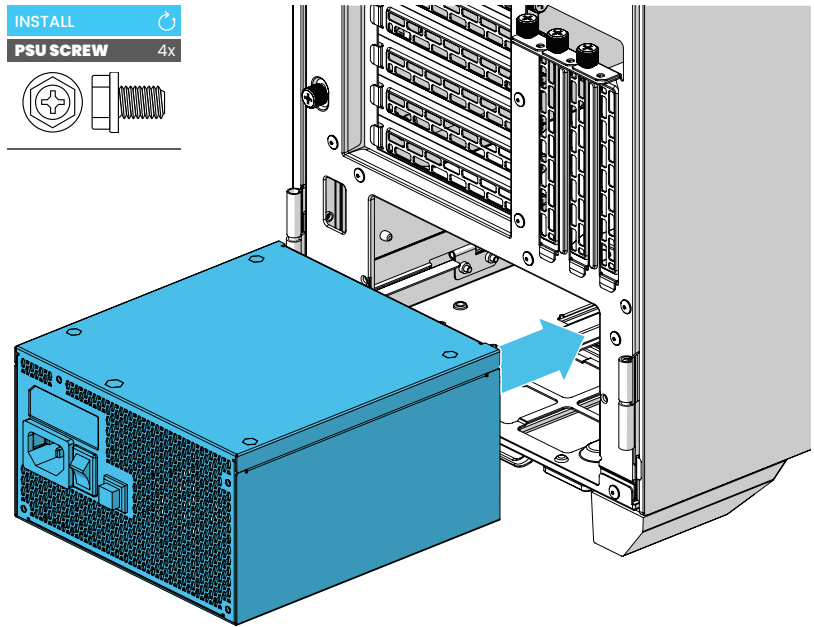
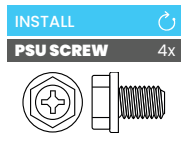

**PRO TIP**  
Pre-connect all needed cables to the PSU before installing it into the chassis. See step 3

**03 CONNECT CABLES TO POWER SUPPLY**

Connect all needed cables to the power supply according to the overview below. The exact connector lay-out and quantity may be different depending on the model.

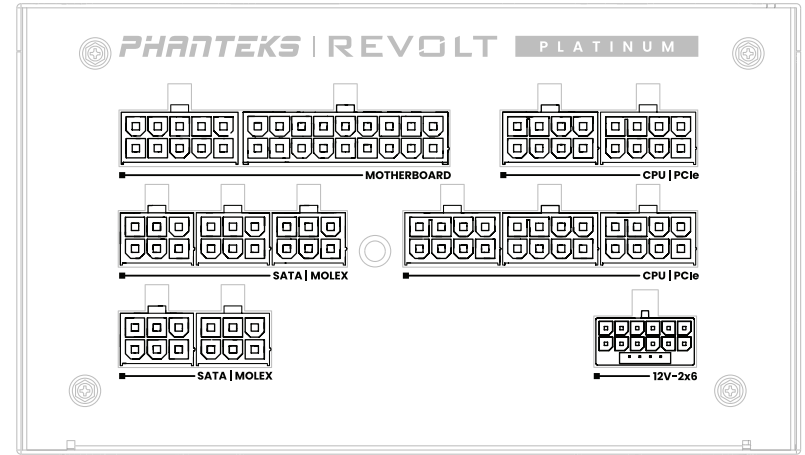

**04 PCIE GEN5.1 GPU CONNECTOR**

The Revolt is equipped with the PCIe GEN5.1 (12V-2x6) GPU connector. Make sure it is fully seated and clicked in to prevent any damage to your system. **Note that a compatible GPU is required.**

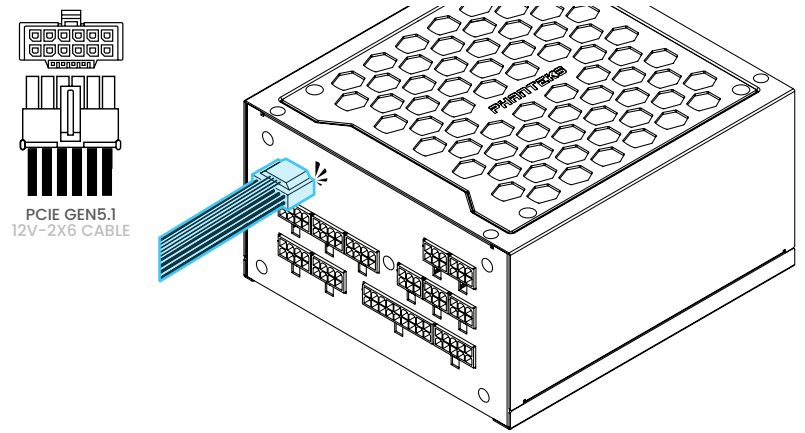

**05 ULTIMATE SILENCE WITH HYBRID FAN CONTROL**

Activate the 0 RPM mode with the Hybrid Fan button on the rear to go for absolute silence when under low load. The Revolt will control the fan speed intelligently based on load and temperature.

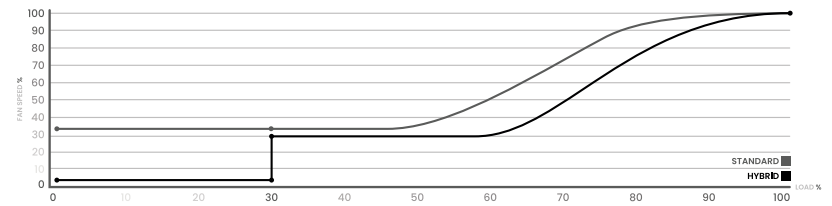

Hybrid Fan Mode is turned **on** when the button is in the 'OUT' position and turned **off** when pushed 'IN'.

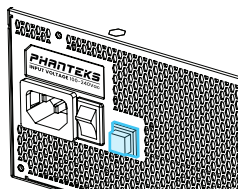

**06 CONNECT POWER CABLE**

Connect the power cable to the power supply and a grounded power outlet respectively. Make sure the power supply is turned off 'O' before connecting it to a power outlet.



**07 BE SAFE!**

Switch the power button to the 'I' position to turn on your system.

When making any changes to the hardware, be sure that the power button is switched from the 'I' to the 'O' position so the power supply is turned off.

